

Notes

- 1. \*\*\* Although a highly specialized technology, glass-to-metal sealing and fabrication is more of an art than a science. As such, glass dimensions are nominal and only provided for reference. Note that glass lengths, diameters, and/or wall thicknesses can vary significantly from part to part. For example, glass adapter lengths can vary by as much as +/- 0.13 inch (3.3mm)\*\*\*
- 2. Glass-to-metal interface diameter is smaller than that of metal or glass tube IDs. Objects inserted through this region must not exceed a 2.17 inch diameter.

Rev.	Description	Date	Made By	Approval
A	Initial Release			

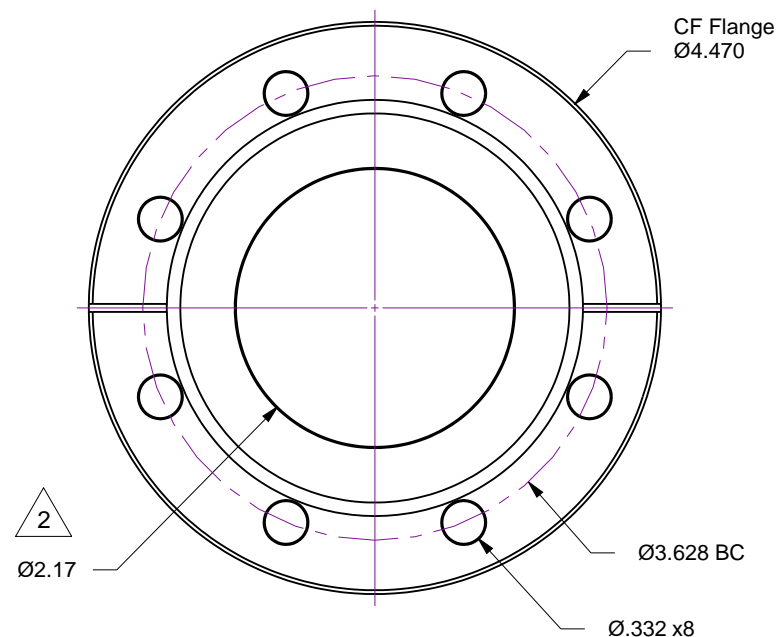
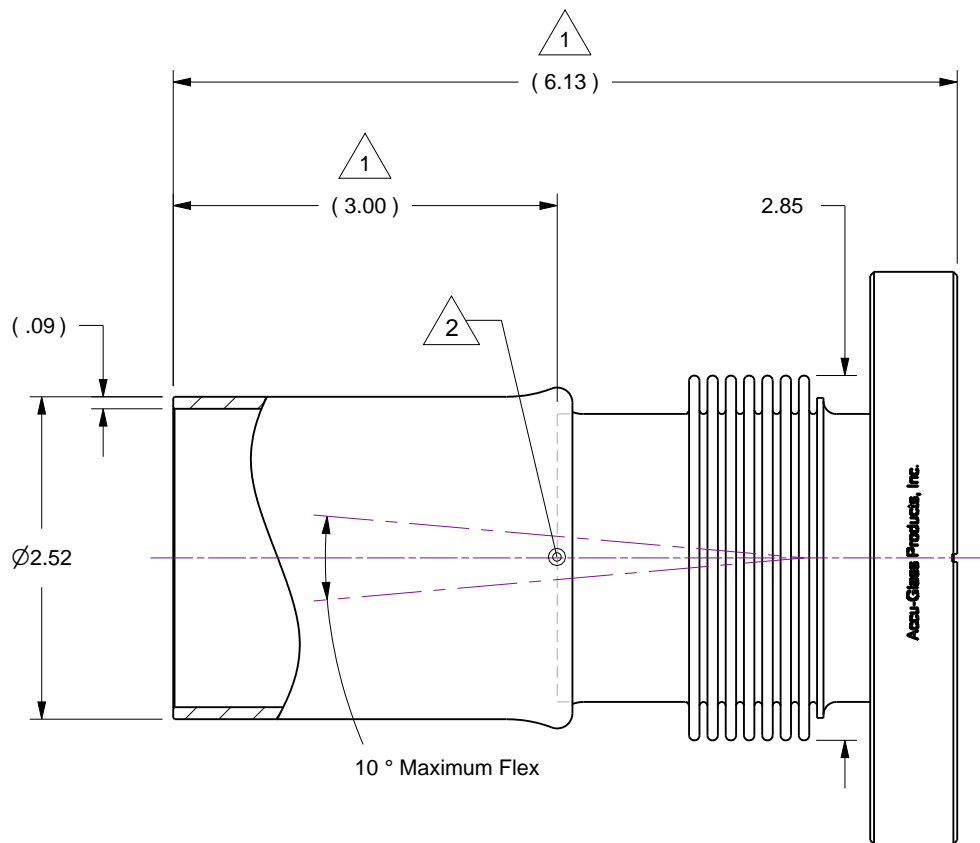
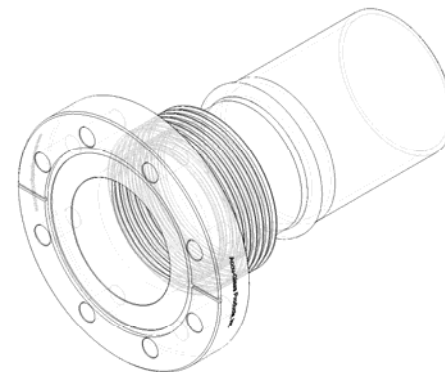

**Accu-Glass Products Inc.**  
 25047 Anza Drive  
 Valencia, CA 91355  
 T 818-365-4215  
 F 818-365-7074  
 www.accuglassproducts.com

**UNCONTROLLED WEB DRAWING**

Proprietary and Confidential  
 The information contained in this drawing is the sole property of Accu-Glass, Products Inc. Any reproduction, in part or as whole, without the written permission of Accu-Glass Products, Inc., is strictly prohibited.

Material 7740 Pyrex	
Tolerances, unless otherwise specified	
.X ± .030	Angles ± 0.5°
.XX ± .010	Finish 63Ra
.XXX ± .005	

Title Glass Adapter, Flexible 2.50 Open-End on 4.50 CF			
Drawn by Date	Ligeti 5/14/2018	No. <b>211073</b>	Rev. <b>A</b>
Approved			Sheet